











**ABSTRACT**

## INTRODUCTION

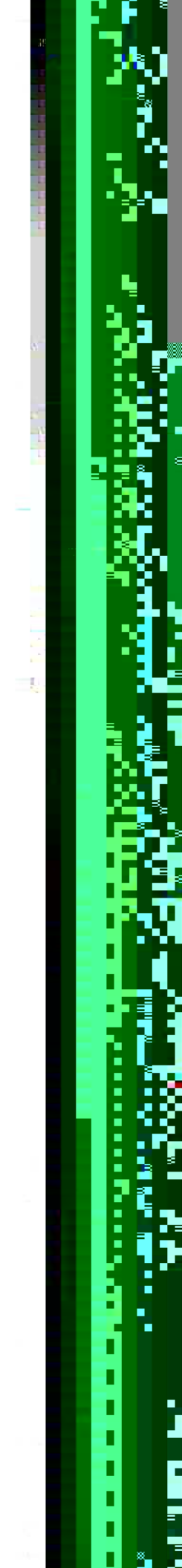

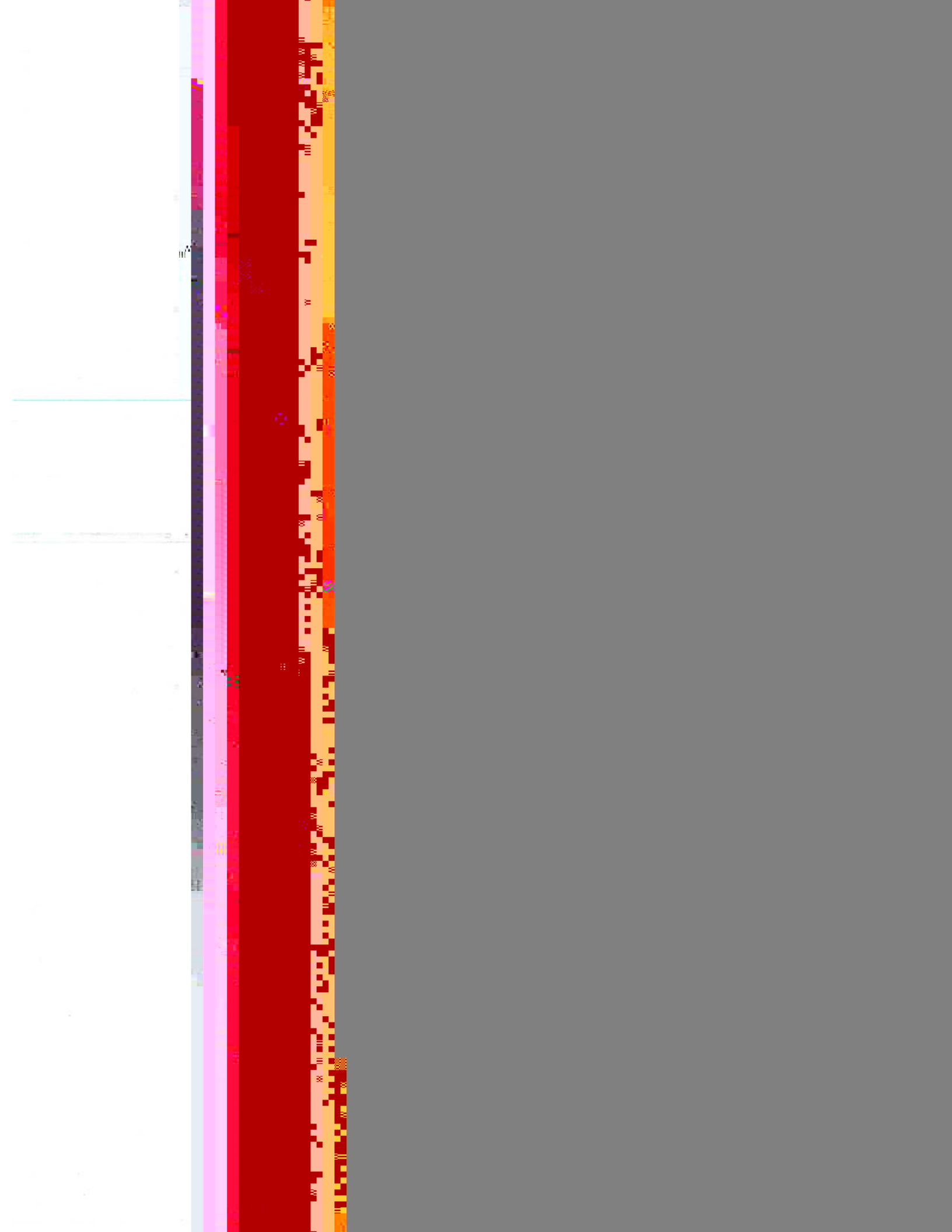







## MATERIALS



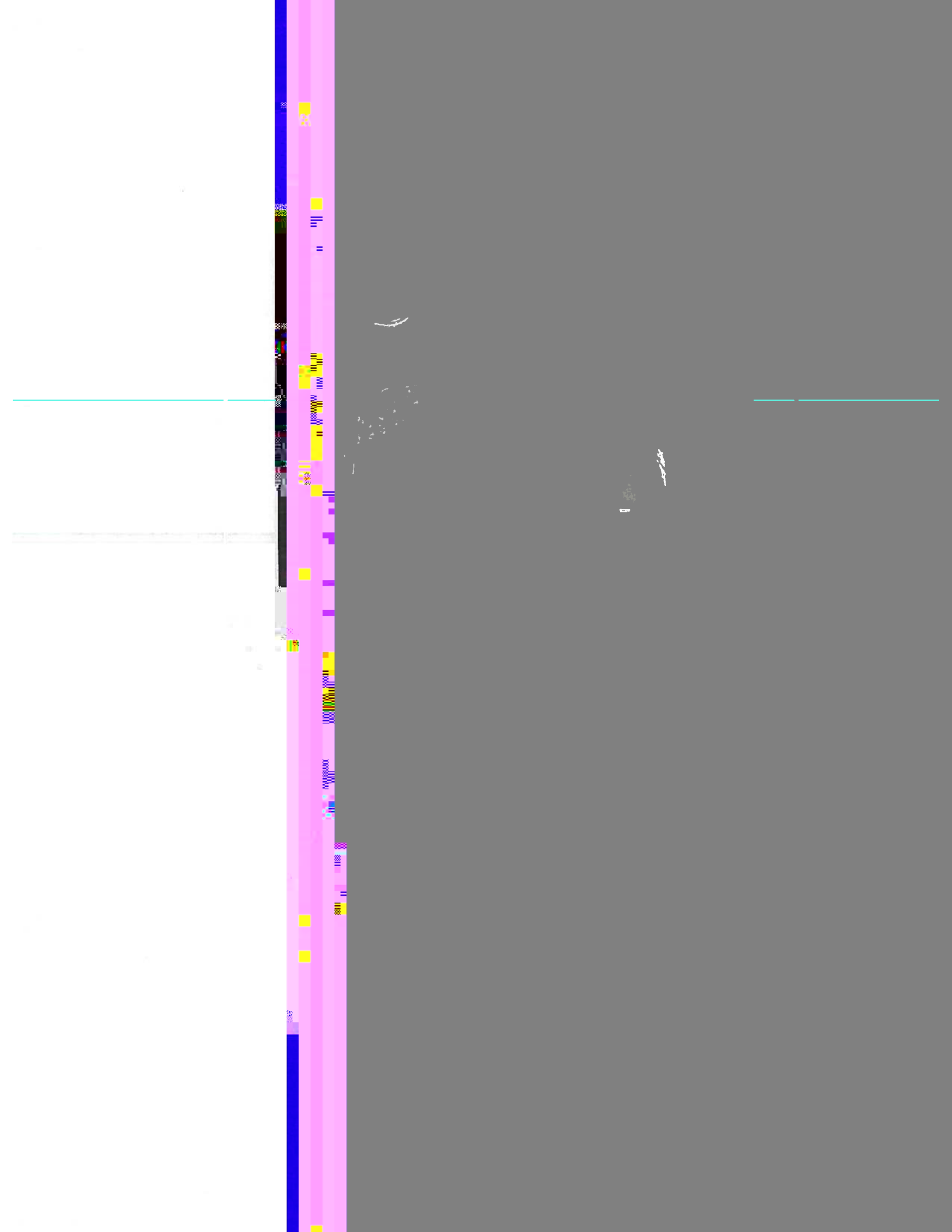

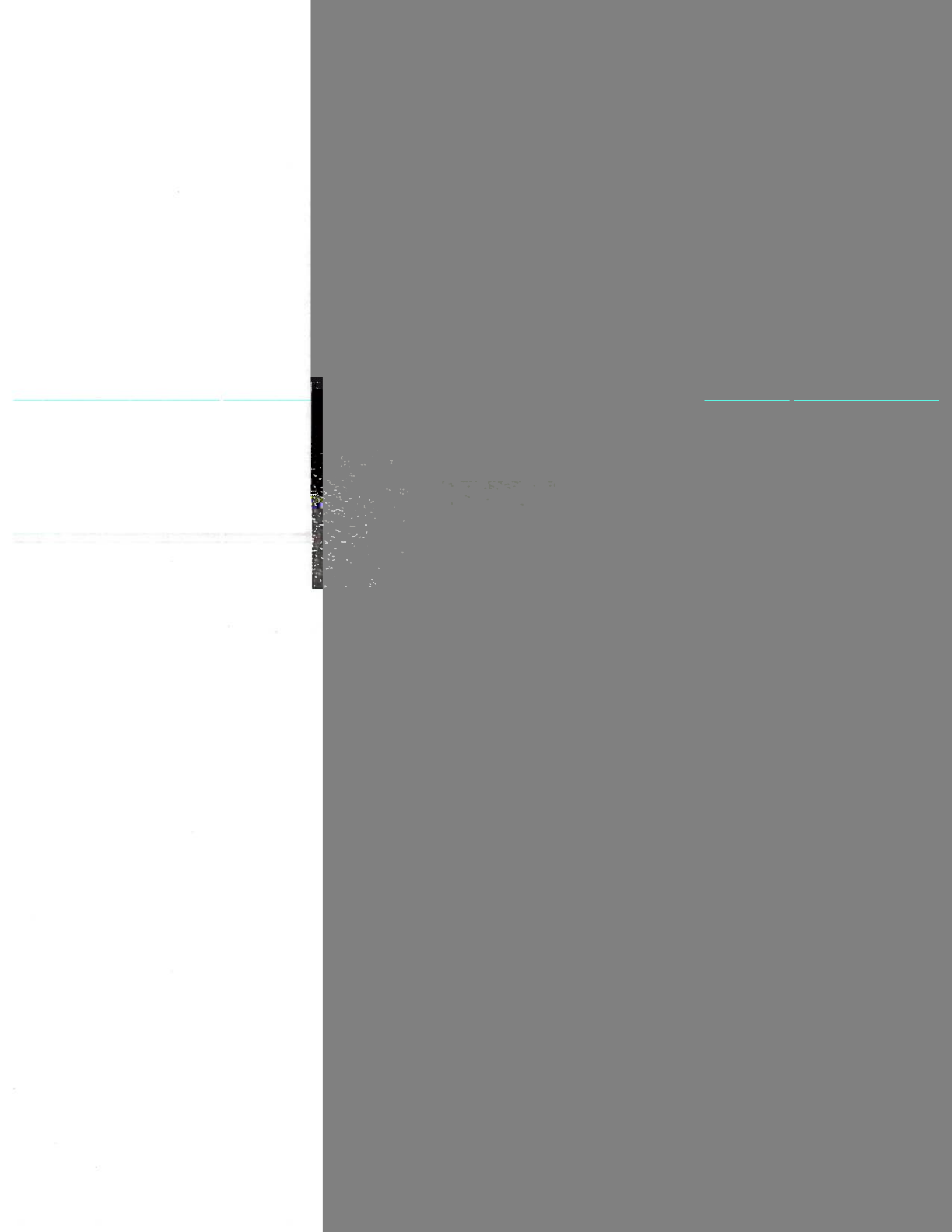



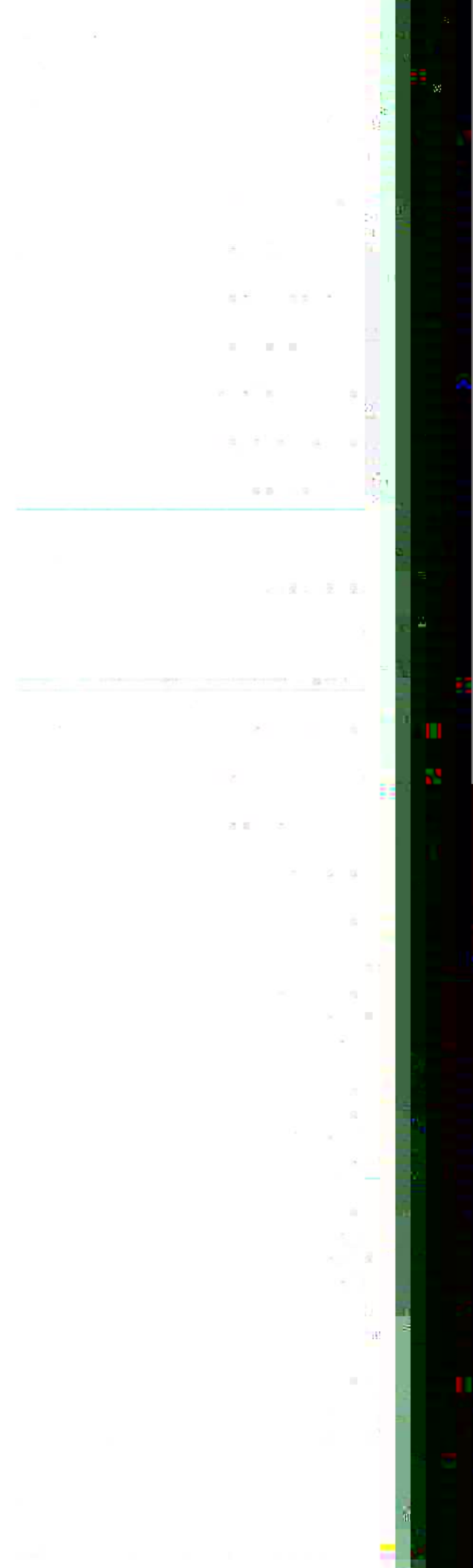

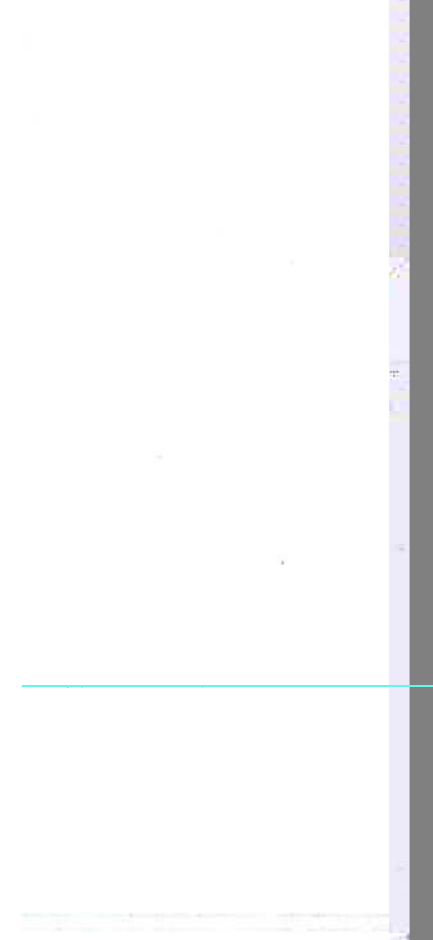



1870  
1871  
1872  
1873  
1874  
1875  
1876  
1877  
1878  
1879  
1880  
1881  
1882  
1883  
1884  
1885  
1886  
1887  
1888  
1889  
1890  
1891  
1892  
1893  
1894  
1895  
1896  
1897  
1898  
1899  
1900  
1901  
1902  
1903  
1904  
1905  
1906  
1907  
1908  
1909  
1910  
1911  
1912  
1913  
1914  
1915  
1916  
1917  
1918  
1919  
1920  
1921  
1922  
1923  
1924  
1925  
1926  
1927  
1928  
1929  
1930  
1931  
1932  
1933  
1934  
1935  
1936  
1937  
1938  
1939  
1940  
1941  
1942  
1943  
1944  
1945  
1946  
1947  
1948  
1949  
1950  
1951  
1952  
1953  
1954  
1955  
1956  
1957  
1958  
1959  
1960  
1961  
1962  
1963  
1964  
1965  
1966  
1967  
1968  
1969  
1970  
1971  
1972  
1973  
1974  
1975  
1976  
1977  
1978  
1979  
1980  
1981  
1982  
1983  
1984  
1985  
1986  
1987  
1988  
1989  
1990  
1991  
1992  
1993  
1994  
1995  
1996  
1997  
1998  
1999  
2000  
2001  
2002  
2003  
2004  
2005  
2006  
2007  
2008  
2009  
2010  
2011  
2012  
2013  
2014  
2015  
2016  
2017  
2018  
2019  
2020  
2021  
2022  
2023  
2024  
2025

1870  
1871  
1872  
1873  
1874  
1875  
1876  
1877  
1878  
1879  
1880  
1881  
1882  
1883  
1884  
1885  
1886  
1887  
1888  
1889  
1890  
1891  
1892  
1893  
1894  
1895  
1896  
1897  
1898  
1899  
1900  
1901  
1902  
1903  
1904  
1905  
1906  
1907  
1908  
1909  
1910  
1911  
1912  
1913  
1914  
1915  
1916  
1917  
1918  
1919  
1920  
1921  
1922  
1923  
1924  
1925  
1926  
1927  
1928  
1929  
1930  
1931  
1932  
1933  
1934  
1935  
1936  
1937  
1938  
1939  
1940  
1941  
1942  
1943  
1944  
1945  
1946  
1947  
1948  
1949  
1950  
1951  
1952  
1953  
1954  
1955  
1956  
1957  
1958  
1959  
1960  
1961  
1962  
1963  
1964  
1965  
1966  
1967  
1968  
1969  
1970  
1971  
1972  
1973  
1974  
1975  
1976  
1977  
1978  
1979  
1980  
1981  
1982  
1983  
1984  
1985  
1986  
1987  
1988  
1989  
1990  
1991  
1992  
1993  
1994  
1995  
1996  
1997  
1998  
1999  
2000  
2001  
2002  
2003  
2004  
2005  
2006  
2007  
2008  
2009  
2010  
2011  
2012  
2013  
2014  
2015  
2016  
2017  
2018  
2019  
2020  
2021  
2022  
2023  
2024  
2025

1870  
1871  
1872  
1873  
1874  
1875  
1876  
1877  
1878  
1879  
1880  
1881  
1882  
1883  
1884  
1885  
1886  
1887  
1888  
1889  
1890  
1891  
1892  
1893  
1894  
1895  
1896  
1897  
1898  
1899  
1900  
1901  
1902  
1903  
1904  
1905  
1906  
1907  
1908  
1909  
1910  
1911  
1912  
1913  
1914  
1915  
1916  
1917  
1918  
1919  
1920  
1921  
1922  
1923  
1924  
1925  
1926  
1927  
1928  
1929  
1930  
1931  
1932  
1933  
1934  
1935  
1936  
1937  
1938  
1939  
1940  
1941  
1942  
1943  
1944  
1945  
1946  
1947  
1948  
1949  
1950  
1951  
1952  
1953  
1954  
1955  
1956  
1957  
1958  
1959  
1960  
1961  
1962  
1963  
1964  
1965  
1966  
1967  
1968  
1969  
1970  
1971  
1972  
1973  
1974  
1975  
1976  
1977  
1978  
1979  
1980  
1981  
1982  
1983  
1984  
1985  
1986  
1987  
1988  
1989  
1990  
1991  
1992  
1993  
1994  
1995  
1996  
1997  
1998  
1999  
2000  
2001  
2002  
2003  
2004  
2005  
2006  
2007  
2008  
2009  
2010  
2011  
2012  
2013  
2014  
2015  
2016  
2017  
2018  
2019  
2020  
2021  
2022  
2023  
2024  
2025

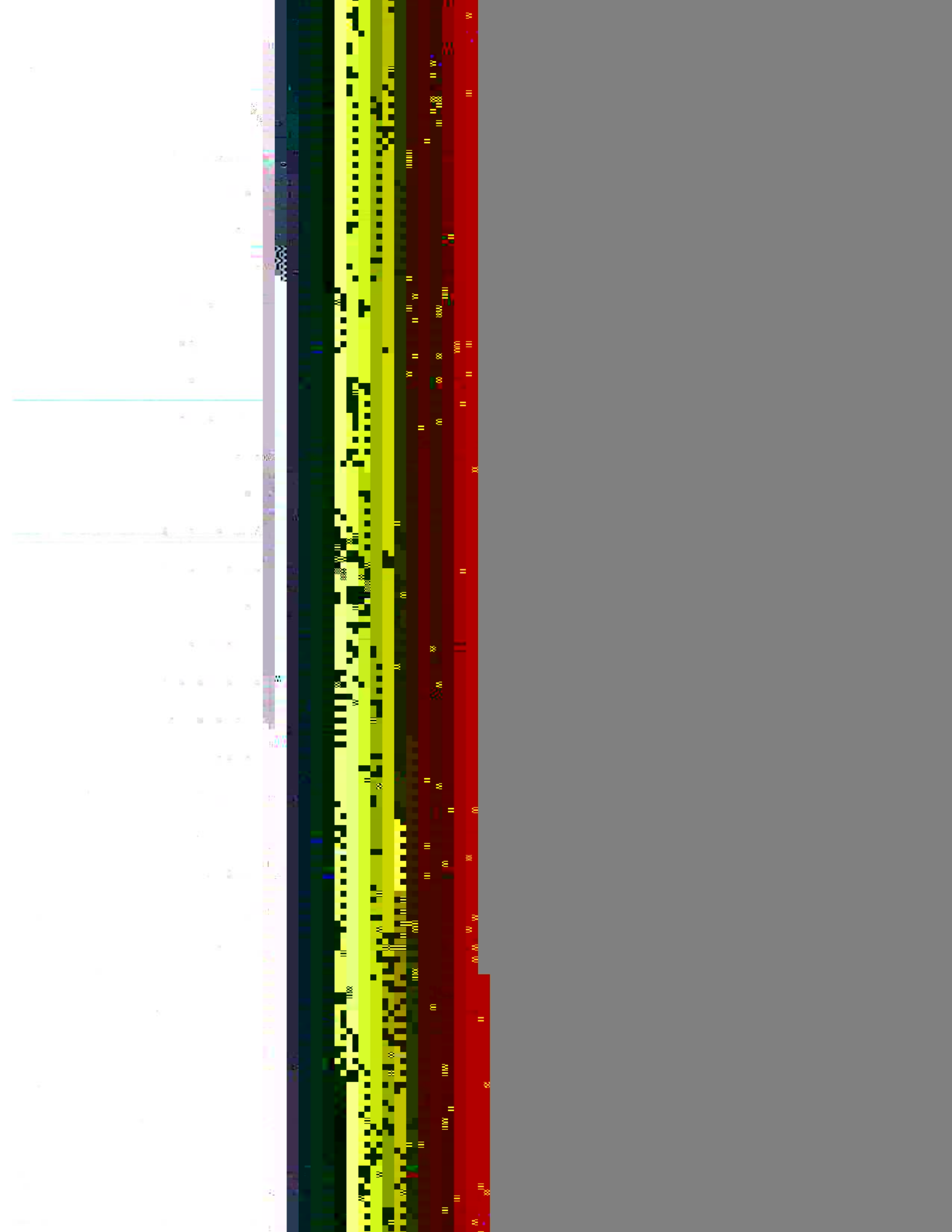









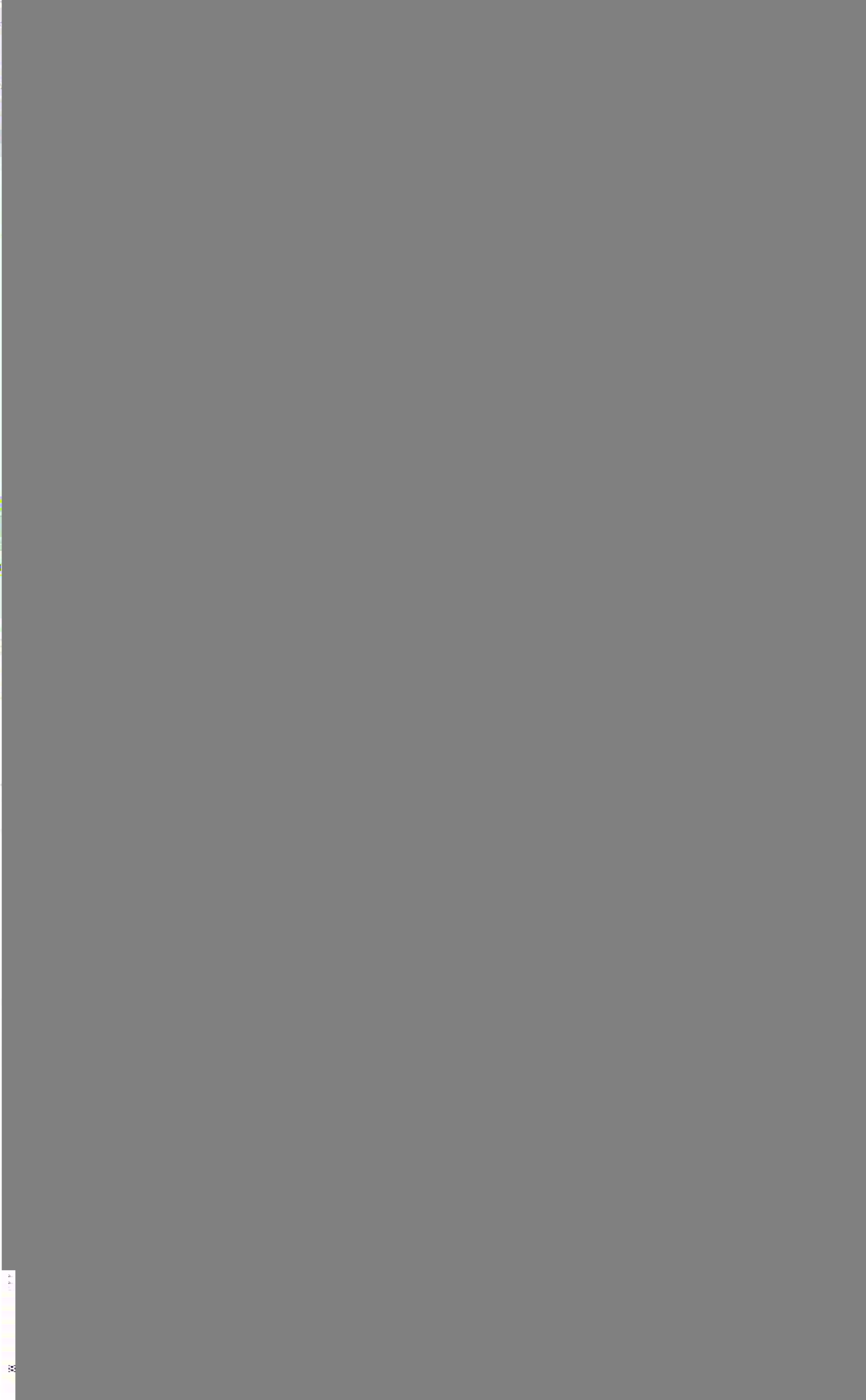





... ..  
... ..  
... ..  
... ..  
... ..  
... ..

1  
2  
3  
4  
5  
6  
7  
8  
9  
10  
11  
12  
13  
14  
15  
16  
17  
18  
19  
20  
21  
22  
23  
24  
25  
26  
27  
28  
29  
30  
31  
32  
33  
34  
35  
36  
37  
38  
39  
40  
41  
42  
43  
44  
45  
46  
47  
48  
49  
50  
51  
52  
53  
54  
55  
56  
57  
58  
59  
60  
61  
62  
63  
64  
65  
66  
67  
68  
69  
70  
71  
72  
73  
74  
75  
76  
77  
78  
79  
80  
81  
82  
83  
84  
85  
86  
87  
88  
89  
90  
91  
92  
93  
94  
95  
96  
97  
98  
99  
100

1  
2  
3  
4  
5  
6  
7  
8  
9  
10  
11  
12  
13  
14  
15  
16  
17  
18  
19  
20  
21  
22  
23  
24  
25  
26  
27  
28  
29  
30  
31  
32  
33  
34  
35  
36  
37  
38  
39  
40  
41  
42  
43  
44  
45  
46  
47  
48  
49  
50  
51  
52  
53  
54  
55  
56  
57  
58  
59  
60  
61  
62  
63  
64  
65  
66  
67  
68  
69  
70  
71  
72  
73  
74  
75  
76  
77  
78  
79  
80  
81  
82  
83  
84  
85  
86  
87  
88  
89  
90  
91  
92  
93  
94  
95  
96  
97  
98  
99  
100



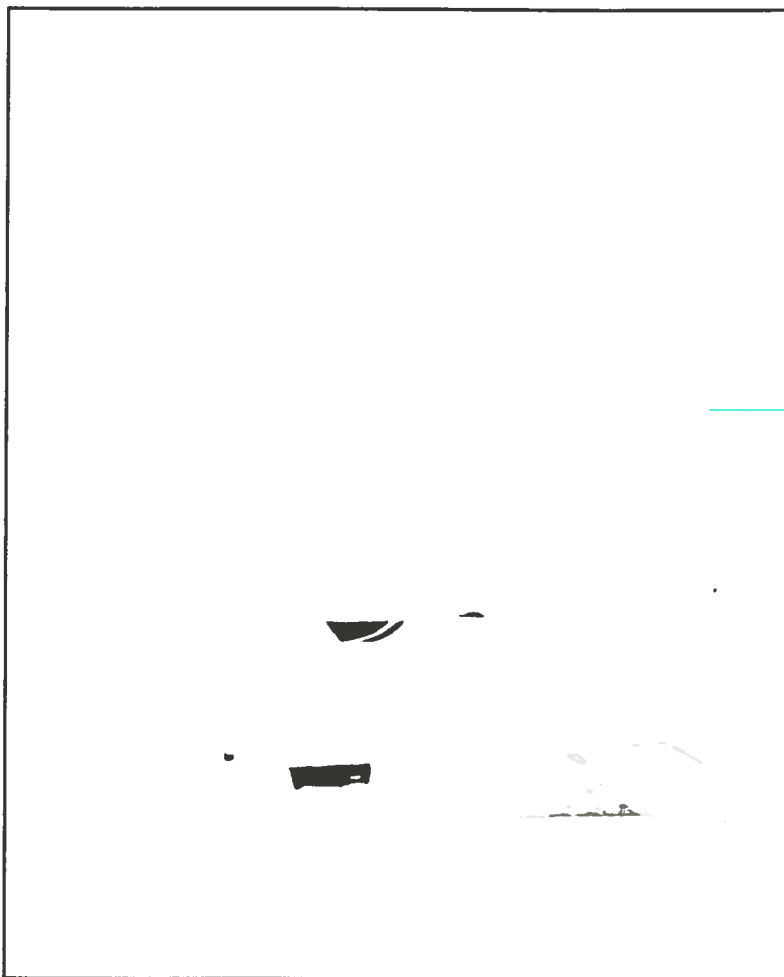

Figure 6 Cross profile setup for clinical cones with film placed at 102.8cm with 2.8cm of buildup (polystyrene) with film placed perpendicular to the beam.

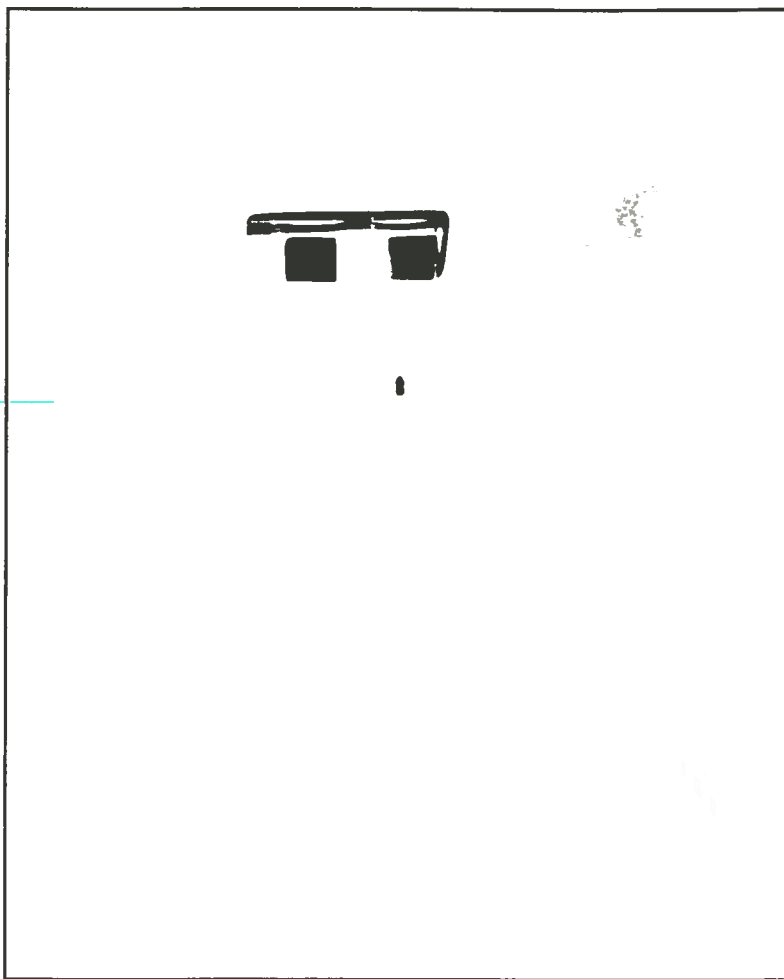
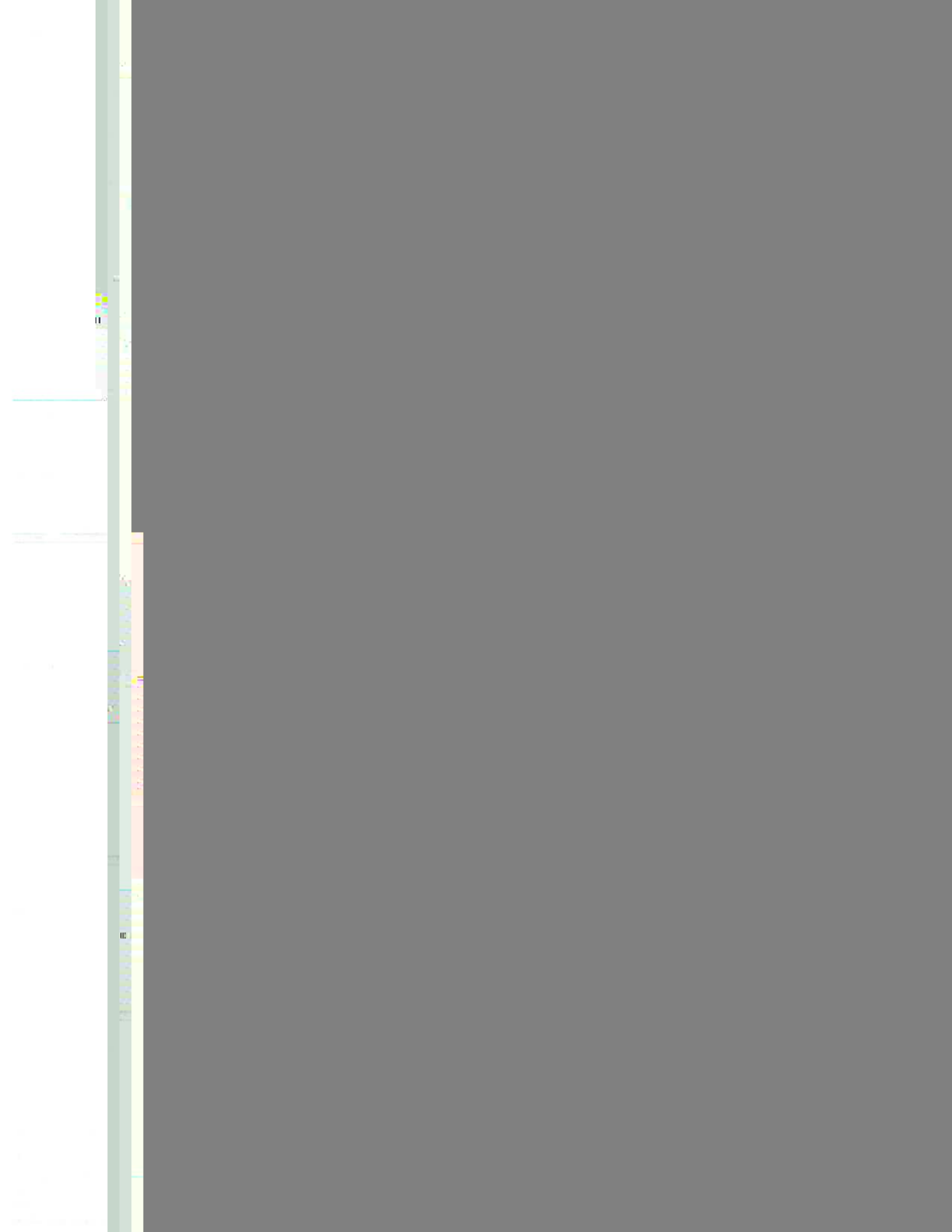

Figure 7 Cross profile setup for film placed parallel to beam central axis with top of phantom placed at 100cm SSD.







1. 2. 3. 4. 5. 6. 7. 8. 9. 10. 11. 12. 13. 14. 15. 16. 17. 18. 19. 20. 21. 22. 23. 24. 25. 26. 27. 28. 29. 30. 31. 32. 33. 34. 35. 36. 37. 38. 39. 40. 41. 42. 43. 44. 45. 46. 47. 48. 49. 50. 51. 52. 53. 54. 55. 56. 57. 58. 59. 60. 61. 62. 63. 64. 65. 66. 67. 68. 69. 70. 71. 72. 73. 74. 75. 76. 77. 78. 79. 80. 81. 82. 83. 84. 85. 86. 87. 88. 89. 90. 91. 92. 93. 94. 95. 96. 97. 98. 99. 100.

101. 102. 103. 104. 105. 106. 107. 108. 109. 110. 111. 112. 113. 114. 115. 116. 117. 118. 119. 120. 121. 122. 123. 124. 125. 126. 127. 128. 129. 130. 131. 132. 133. 134. 135. 136. 137. 138. 139. 140. 141. 142. 143. 144. 145. 146. 147. 148. 149. 150.

151. 152. 153. 154. 155. 156. 157. 158. 159. 160. 161. 162. 163. 164. 165. 166. 167. 168. 169. 170. 171. 172. 173. 174. 175. 176. 177. 178. 179. 180. 181. 182. 183. 184. 185. 186. 187. 188. 189. 190. 191. 192. 193. 194. 195. 196. 197. 198. 199. 200.

201. 202. 203. 204. 205. 206. 207. 208. 209. 210. 211. 212. 213. 214. 215. 216. 217. 218. 219. 220. 221. 222. 223. 224. 225. 226. 227. 228. 229. 230. 231. 232. 233. 234. 235. 236. 237. 238. 239. 240. 241. 242. 243. 244. 245. 246. 247. 248. 249. 250.

251. 252. 253. 254. 255. 256. 257. 258. 259. 260. 261. 262. 263. 264. 265. 266. 267. 268. 269. 270. 271. 272. 273. 274. 275. 276. 277. 278. 279. 280. 281. 282. 283. 284. 285. 286. 287. 288. 289. 290. 291. 292. 293. 294. 295. 296. 297. 298. 299. 300.

301. 302. 303. 304. 305. 306. 307. 308. 309. 310. 311. 312. 313. 314. 315. 316. 317. 318. 319. 320. 321. 322. 323. 324. 325. 326. 327. 328. 329. 330. 331. 332. 333. 334. 335. 336. 337. 338. 339. 340. 341. 342. 343. 344. 345. 346. 347. 348. 349. 350.

351. 352. 353. 354. 355. 356. 357. 358. 359. 360. 361. 362. 363. 364. 365. 366. 367. 368. 369. 370. 371. 372. 373. 374. 375. 376. 377. 378. 379. 380. 381. 382. 383. 384. 385. 386. 387. 388. 389. 390. 391. 392. 393. 394. 395. 396. 397. 398. 399. 400.

401. 402. 403. 404. 405. 406. 407. 408. 409. 410. 411. 412. 413. 414. 415. 416. 417. 418. 419. 420. 421. 422. 423. 424. 425. 426. 427. 428. 429. 430. 431. 432. 433. 434. 435. 436. 437. 438. 439. 440. 441. 442. 443. 444. 445. 446. 447. 448. 449. 450.







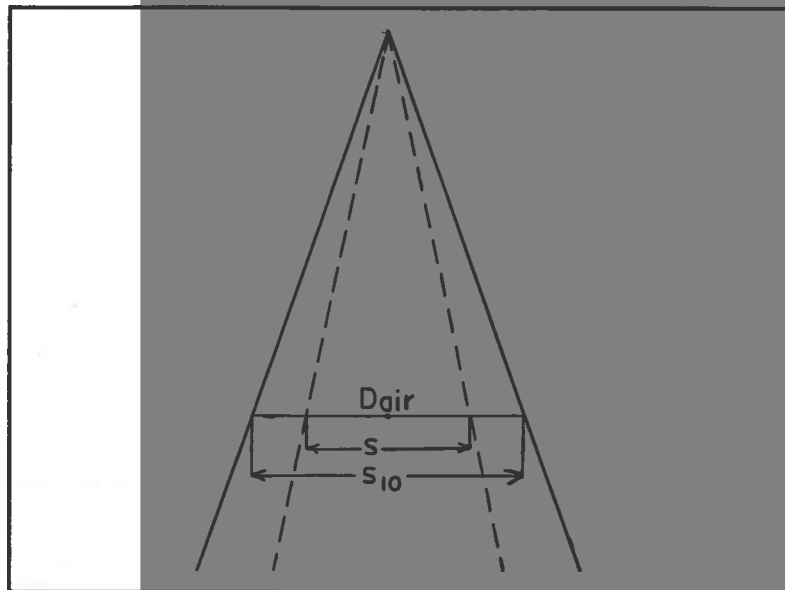











**Figure 11** The field size dependence in air is determined from the equation  $S_c(s) = D_{\text{air}}(s) / D_{\text{air}}(s_{10})$  following the setup above.







1. The first part of the text discusses the importance of maintaining accurate records in a laboratory setting. It emphasizes that proper documentation is essential for ensuring the reliability and reproducibility of experimental results. This includes recording the date, time, and location of each experiment, as well as the names of the individuals involved and the specific procedures followed.

2. The second part of the text focuses on the role of safety protocols in a laboratory environment. It highlights the need for all personnel to be thoroughly trained in safety procedures and to adhere strictly to these protocols at all times. This includes wearing appropriate personal protective equipment (PPE), such as lab coats, gloves, and safety glasses, and following established guidelines for handling hazardous materials and equipment.

3. The third part of the text addresses the importance of effective communication in a laboratory setting. It stresses that clear and concise communication is crucial for ensuring that all team members are aware of their roles and responsibilities, and for facilitating the timely resolution of any issues that may arise. This includes providing regular updates on the progress of ongoing experiments and being open to receiving feedback from colleagues.



4. The fourth part of the text discusses the importance of maintaining a clean and organized laboratory environment. It emphasizes that a well-maintained workspace is essential for ensuring the accuracy and safety of experiments. This includes regularly cleaning work surfaces, disposing of waste properly, and ensuring that all equipment is properly calibrated and maintained.

5. The fifth part of the text focuses on the importance of staying up-to-date on the latest research and developments in the field. It stresses that continuous learning and professional development are essential for ensuring that laboratory personnel are equipped with the most current knowledge and skills needed to conduct cutting-edge research.

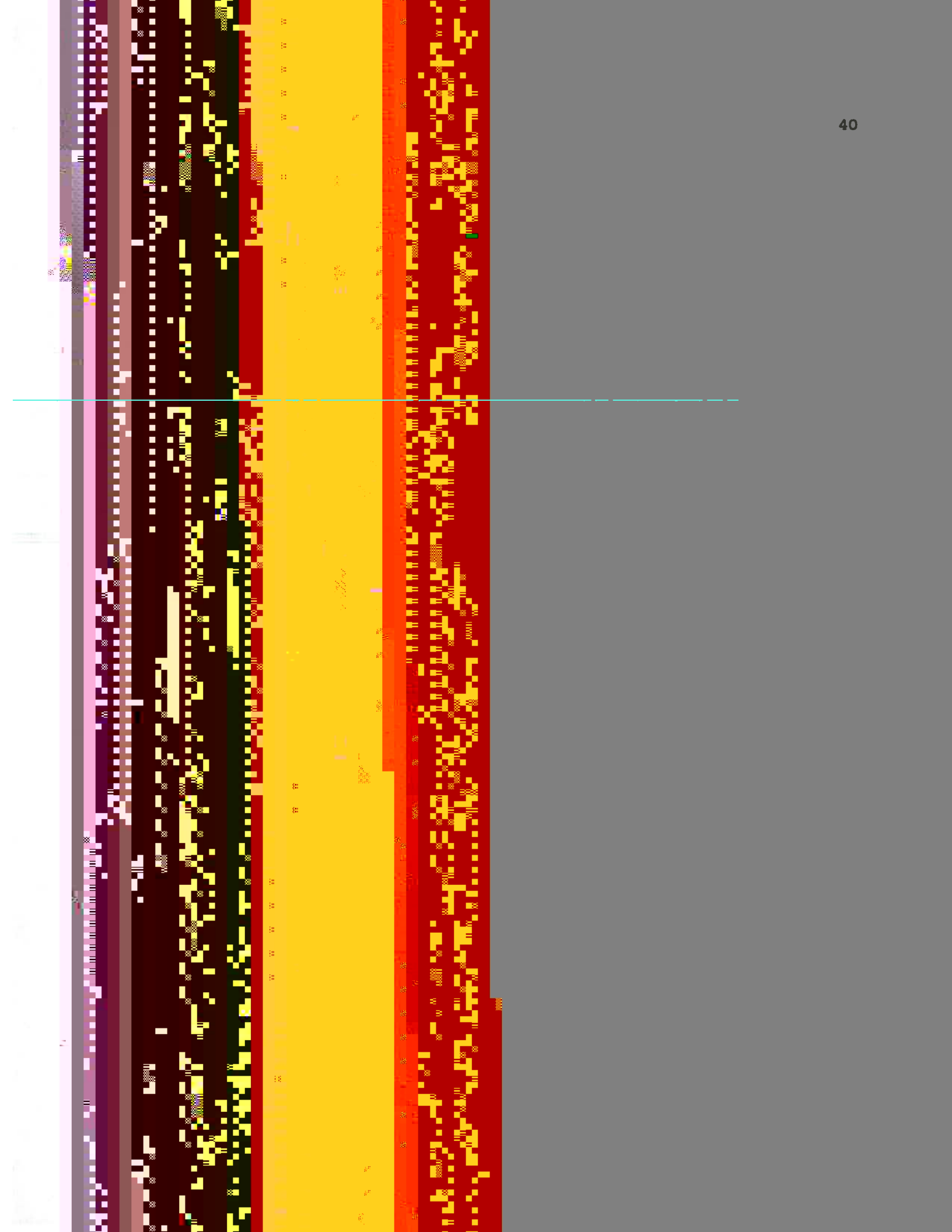















11

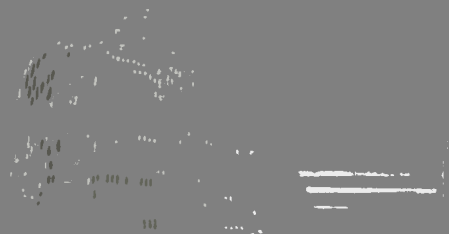



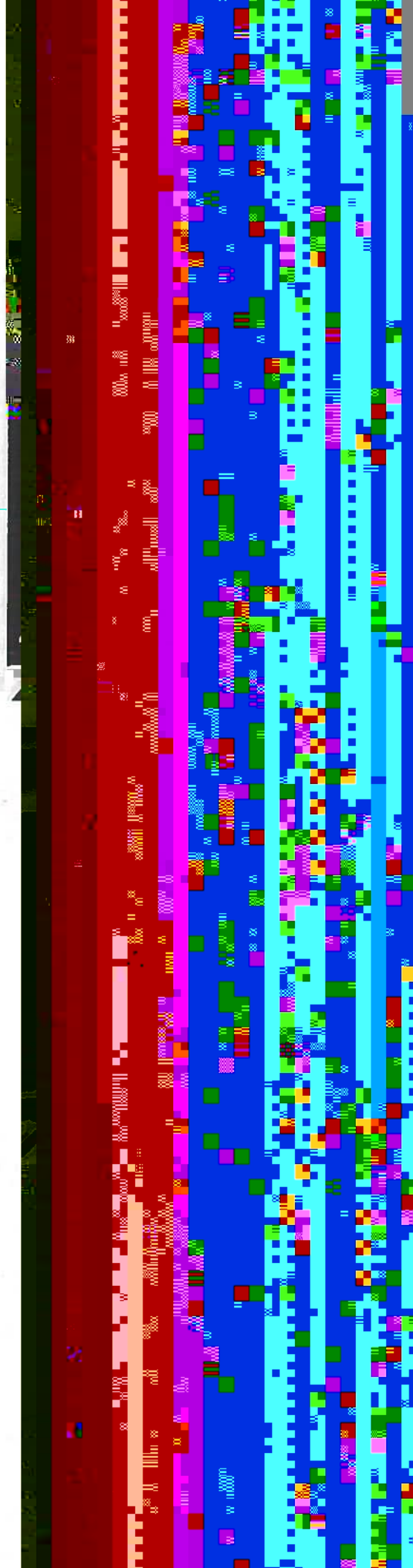



1

2

3

4

5

6

7

8

9

10

11

12

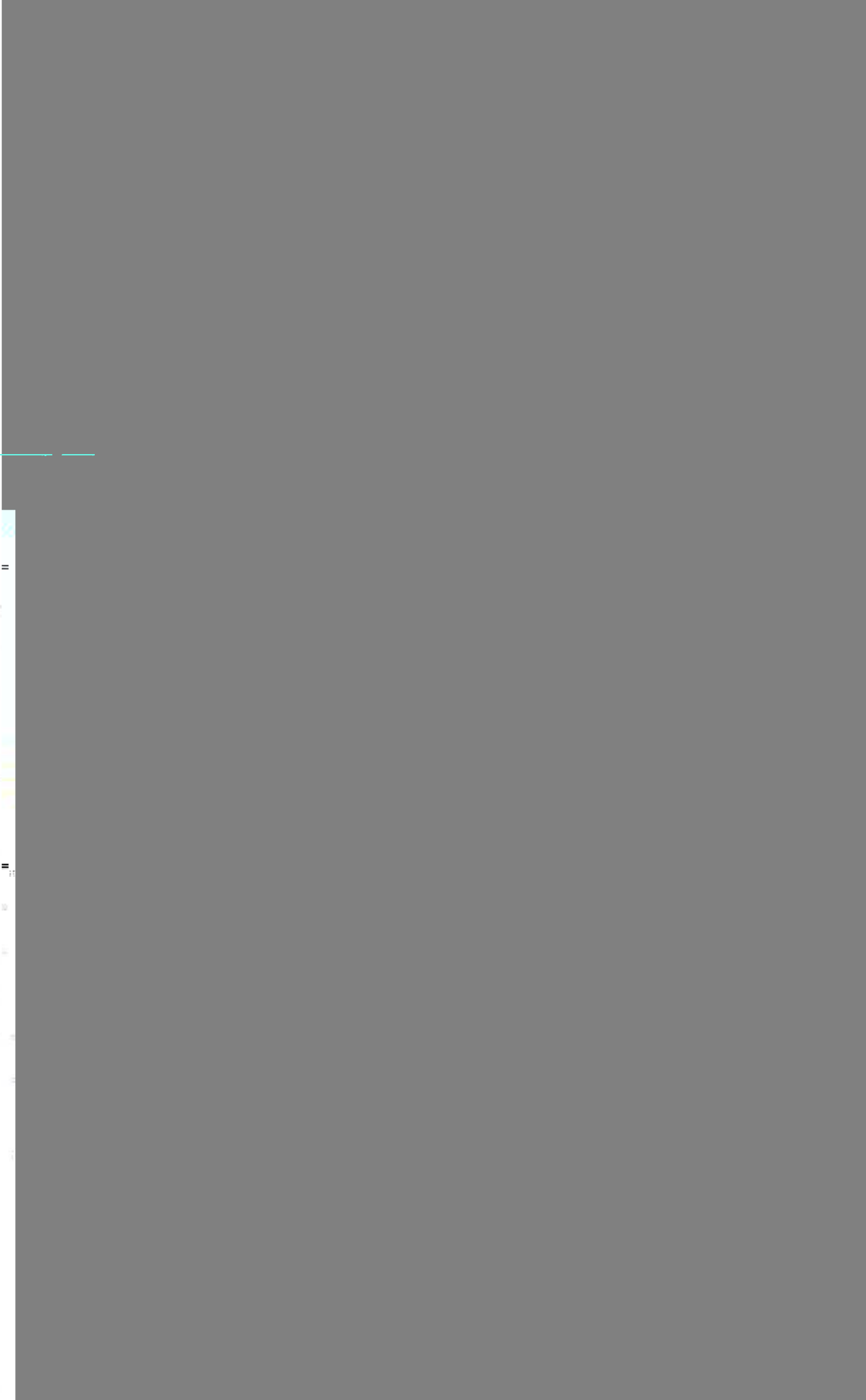

## RESULTS AND DISCUSSION

2019年12月  
第 2 卷  
第 1 期  
第 1 页

2019年12月  
第 2 卷  
第 1 期  
第 1 页

2019年12月  
第 2 卷  
第 1 期  
第 1 页

2019年12月  
第 2 卷  
第 1 期  
第 1 页







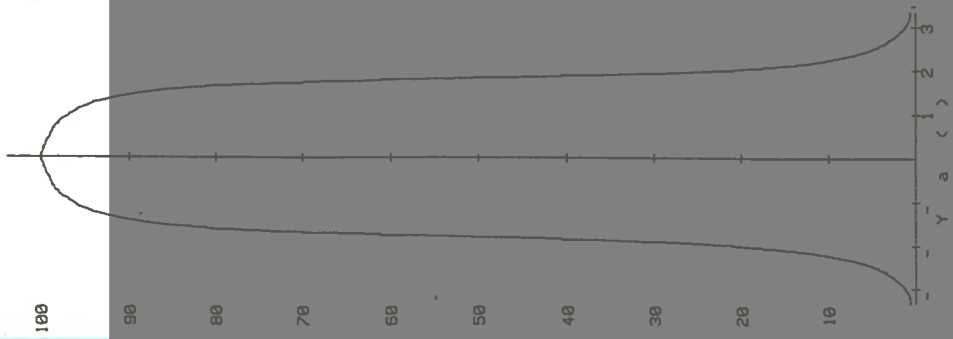



am





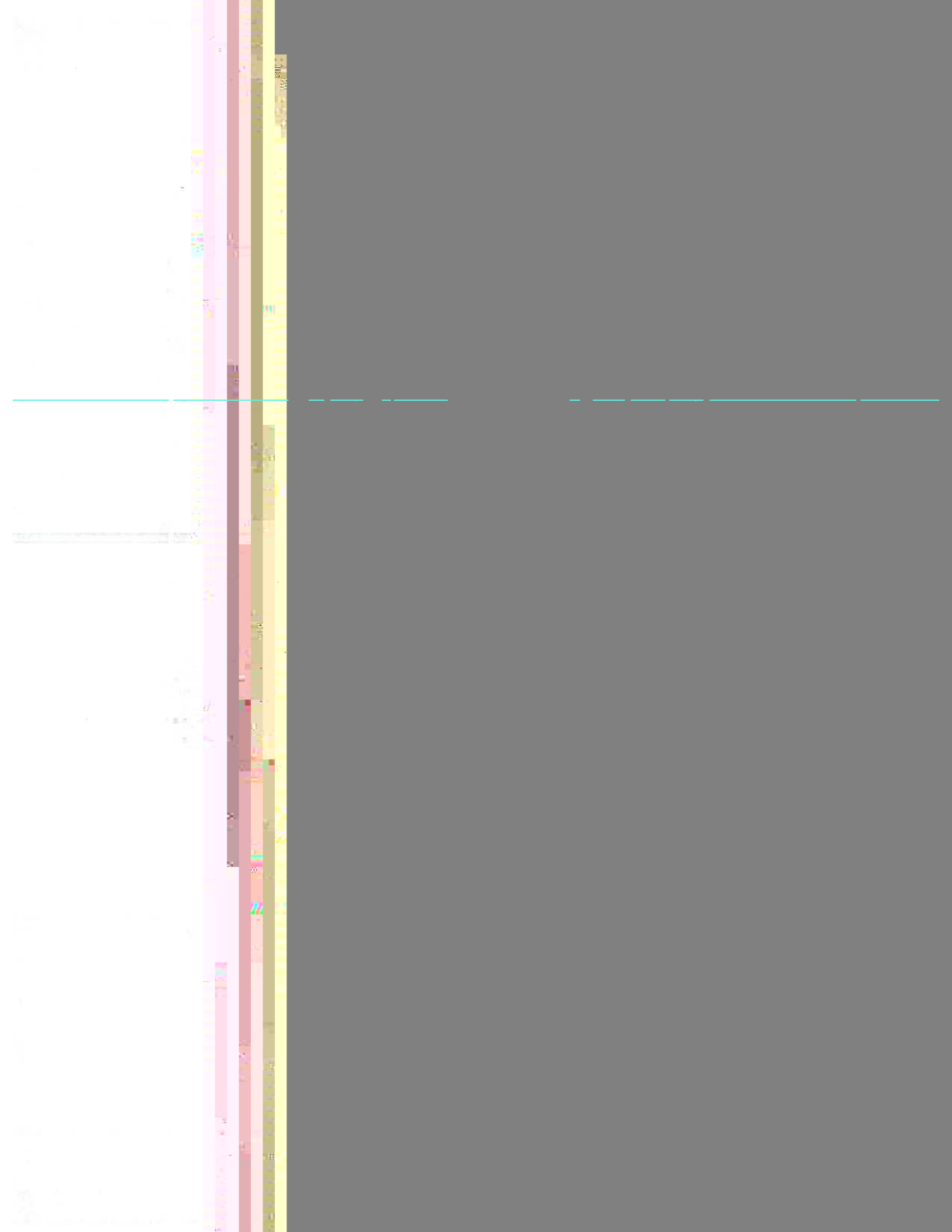

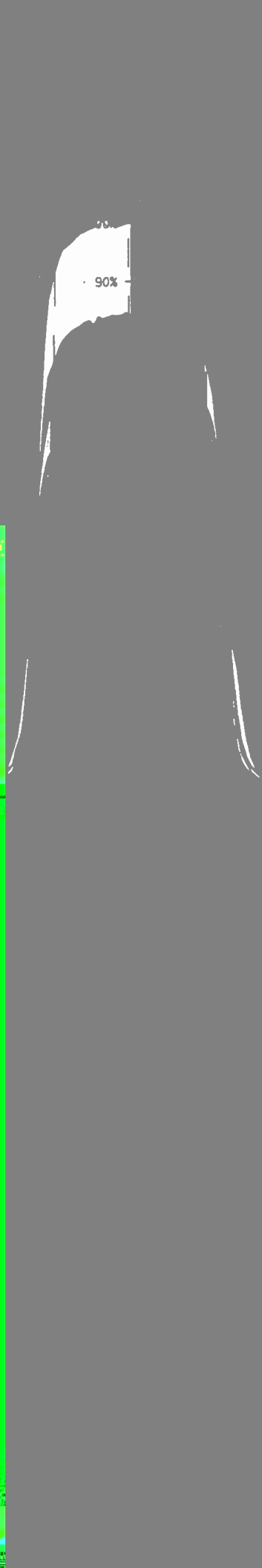
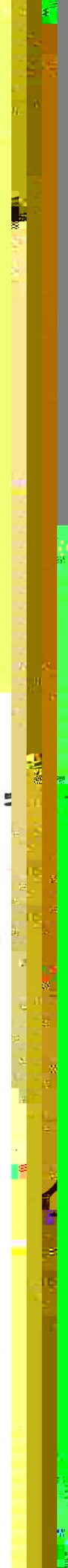

90%



Perp

CONE 1  
90/10%  
80/20%

CONE 2  
90/10%  
80/20%



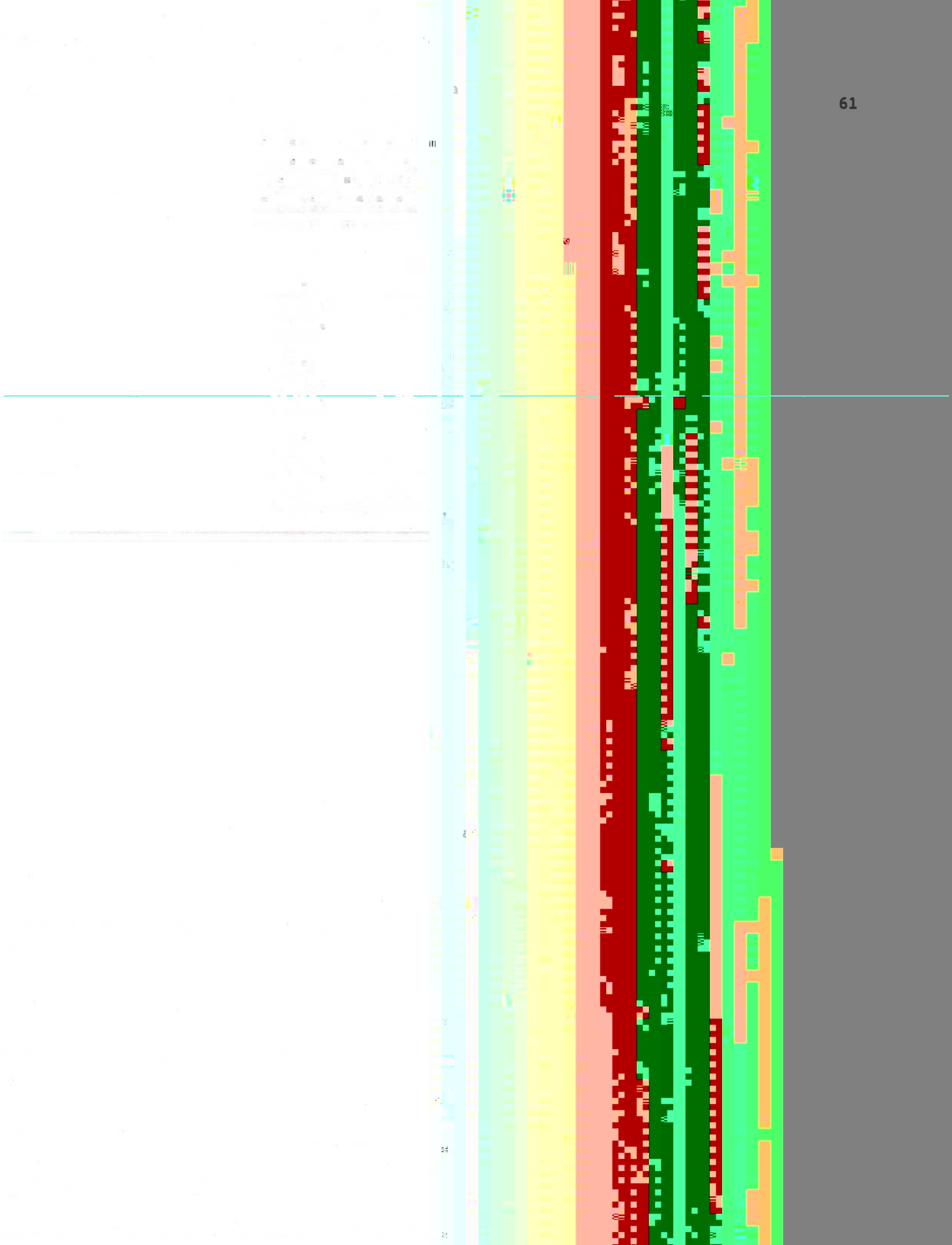



| 日期     | 星期  | 上午 | 下午 | 备注 |
|--------|-----|----|----|----|
| 10月1日  | 星期一 | 上课 | 上课 |    |
| 10月2日  | 星期二 | 上课 | 上课 |    |
| 10月3日  | 星期三 | 上课 | 上课 |    |
| 10月4日  | 星期四 | 上课 | 上课 |    |
| 10月5日  | 星期五 | 上课 | 上课 |    |
| 10月6日  | 星期六 | 休息 | 休息 |    |
| 10月7日  | 星期日 | 休息 | 休息 |    |
| 10月8日  | 星期一 | 上课 | 上课 |    |
| 10月9日  | 星期二 | 上课 | 上课 |    |
| 10月10日 | 星期三 | 上课 | 上课 |    |
| 10月11日 | 星期四 | 上课 | 上课 |    |
| 10月12日 | 星期五 | 上课 | 上课 |    |
| 10月13日 | 星期六 | 休息 | 休息 |    |
| 10月14日 | 星期日 | 休息 | 休息 |    |
| 10月15日 | 星期一 | 上课 | 上课 |    |
| 10月16日 | 星期二 | 上课 | 上课 |    |
| 10月17日 | 星期三 | 上课 | 上课 |    |
| 10月18日 | 星期四 | 上课 | 上课 |    |
| 10月19日 | 星期五 | 上课 | 上课 |    |
| 10月20日 | 星期六 | 休息 | 休息 |    |
| 10月21日 | 星期日 | 休息 | 休息 |    |
| 10月22日 | 星期一 | 上课 | 上课 |    |
| 10月23日 | 星期二 | 上课 | 上课 |    |
| 10月24日 | 星期三 | 上课 | 上课 |    |
| 10月25日 | 星期四 | 上课 | 上课 |    |
| 10月26日 | 星期五 | 上课 | 上课 |    |
| 10月27日 | 星期六 | 休息 | 休息 |    |
| 10月28日 | 星期日 | 休息 | 休息 |    |
| 10月29日 | 星期一 | 上课 | 上课 |    |
| 10月30日 | 星期二 | 上课 | 上课 |    |
| 10月31日 | 星期三 | 上课 | 上课 |    |

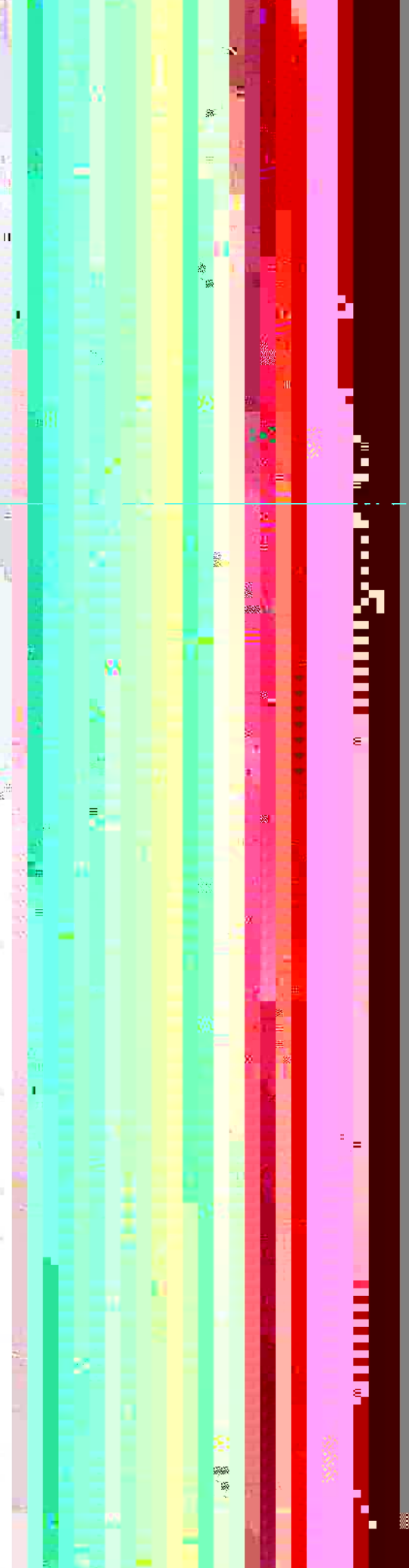



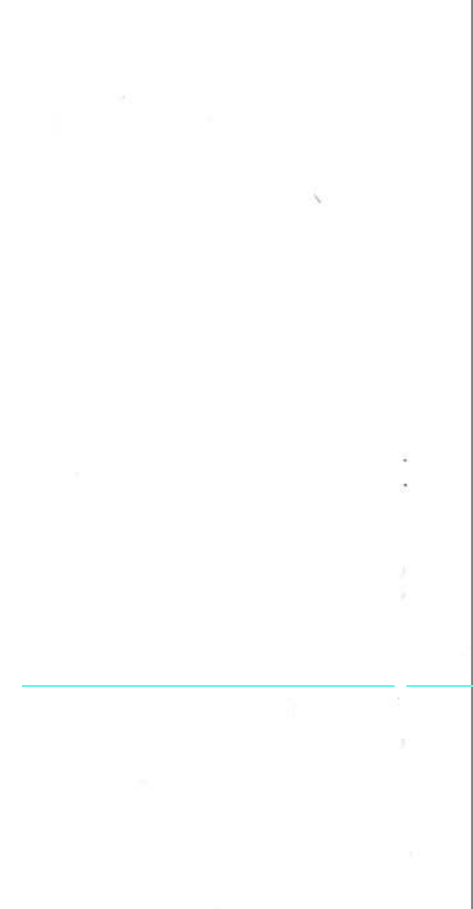





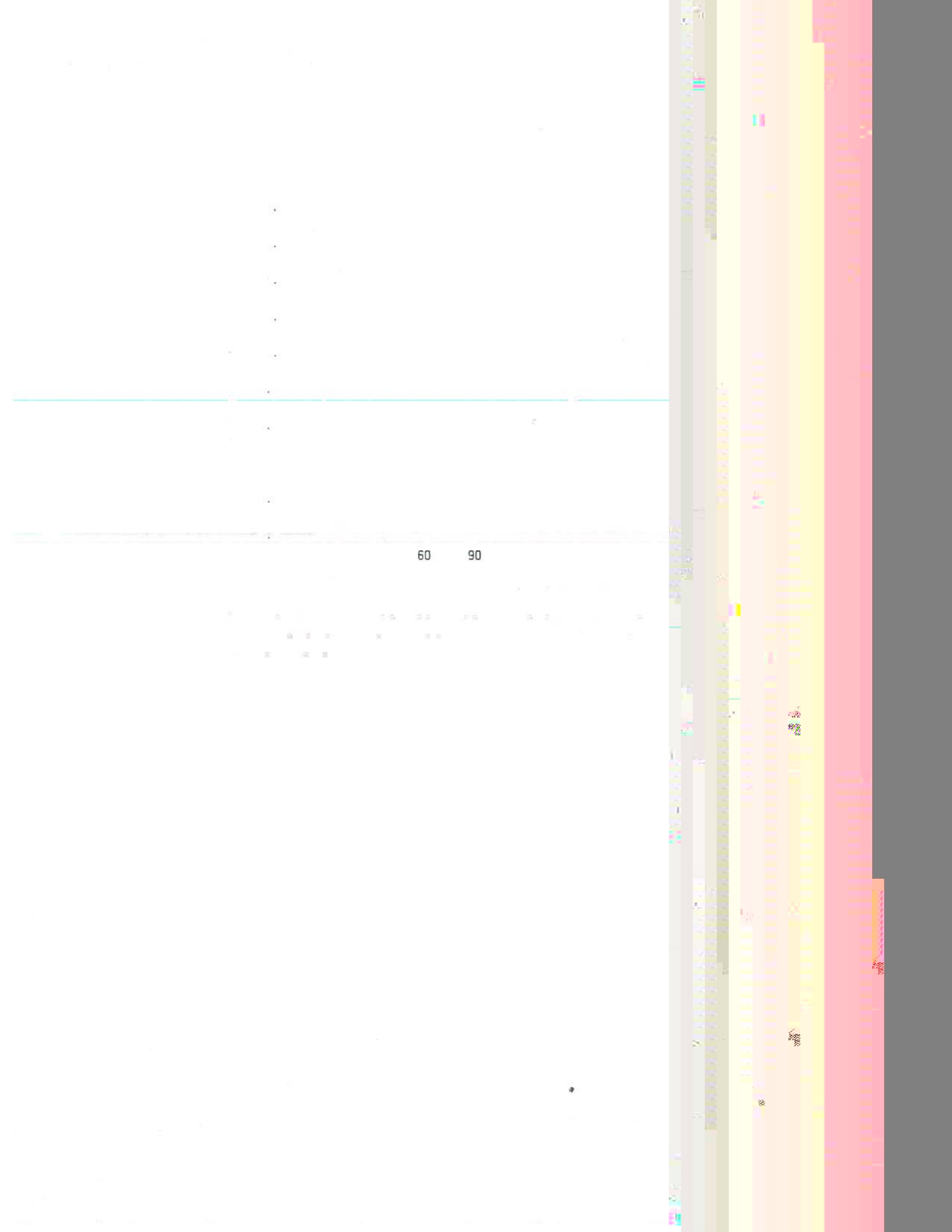



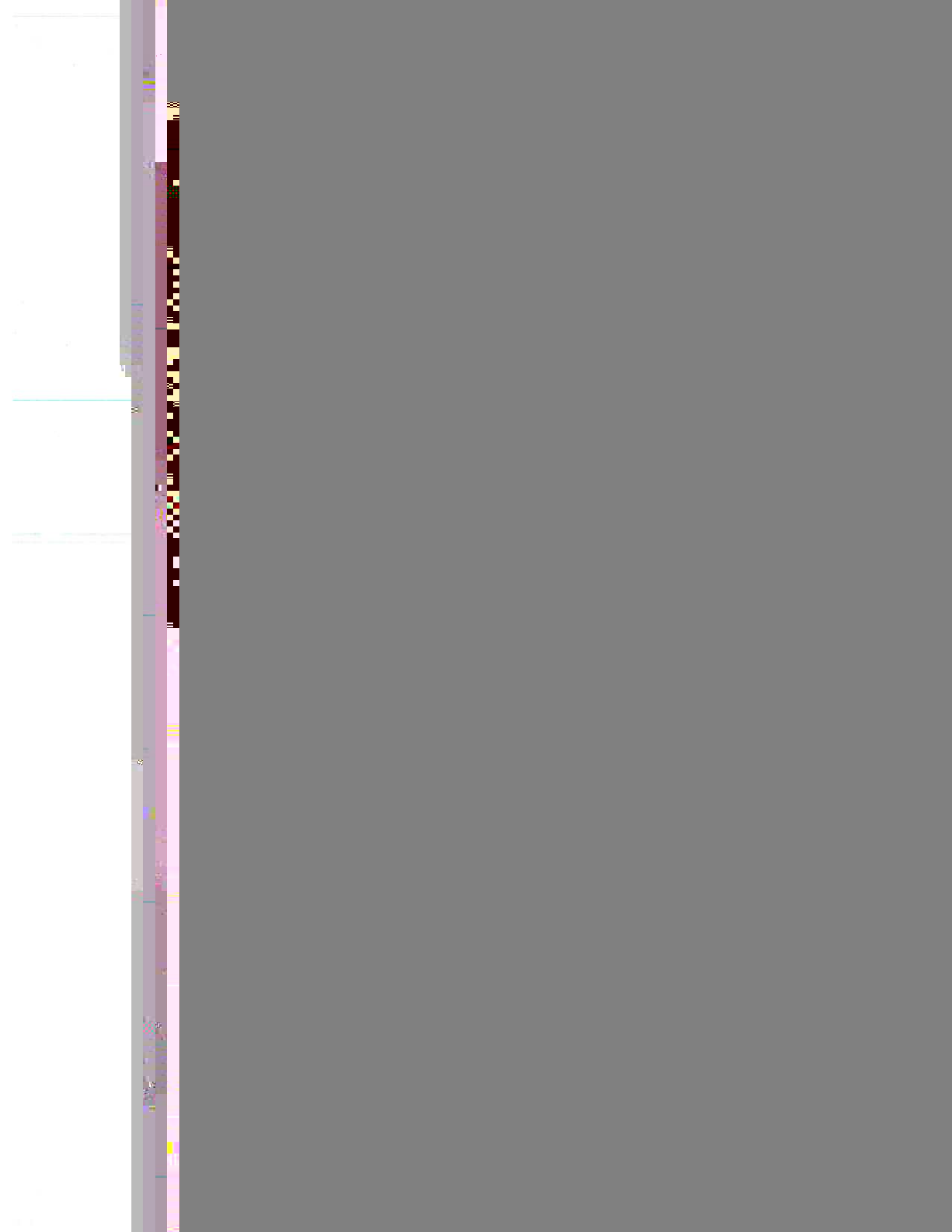

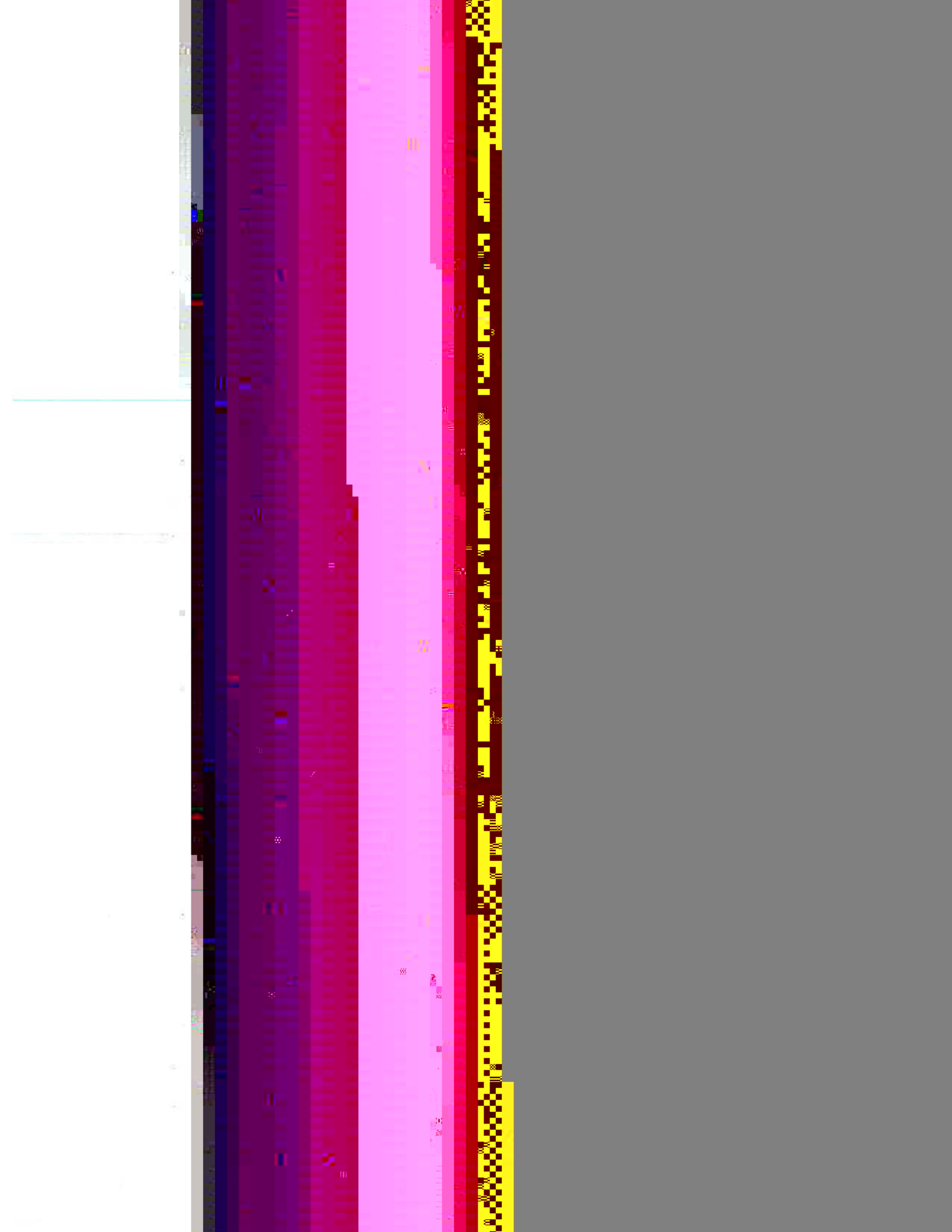







1990-1991  
1991-1992  
1992-1993  
1993-1994  
1994-1995  
1995-1996  
1996-1997  
1997-1998  
1998-1999  
1999-2000  
2000-2001  
2001-2002  
2002-2003  
2003-2004  
2004-2005  
2005-2006  
2006-2007  
2007-2008  
2008-2009  
2009-2010  
2010-2011  
2011-2012  
2012-2013  
2013-2014  
2014-2015  
2015-2016  
2016-2017  
2017-2018  
2018-2019  
2019-2020  
2020-2021









2020

2021

2022

2023

2024

2025

2026

2027

2028

2029

2030

2031

2032

2033

2034

2035

2036

2037

2038

2039

2040

2041

2042

2043

2044

2045



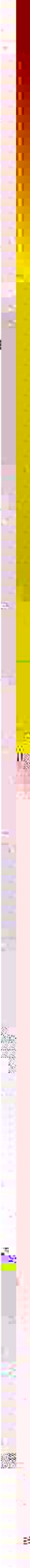

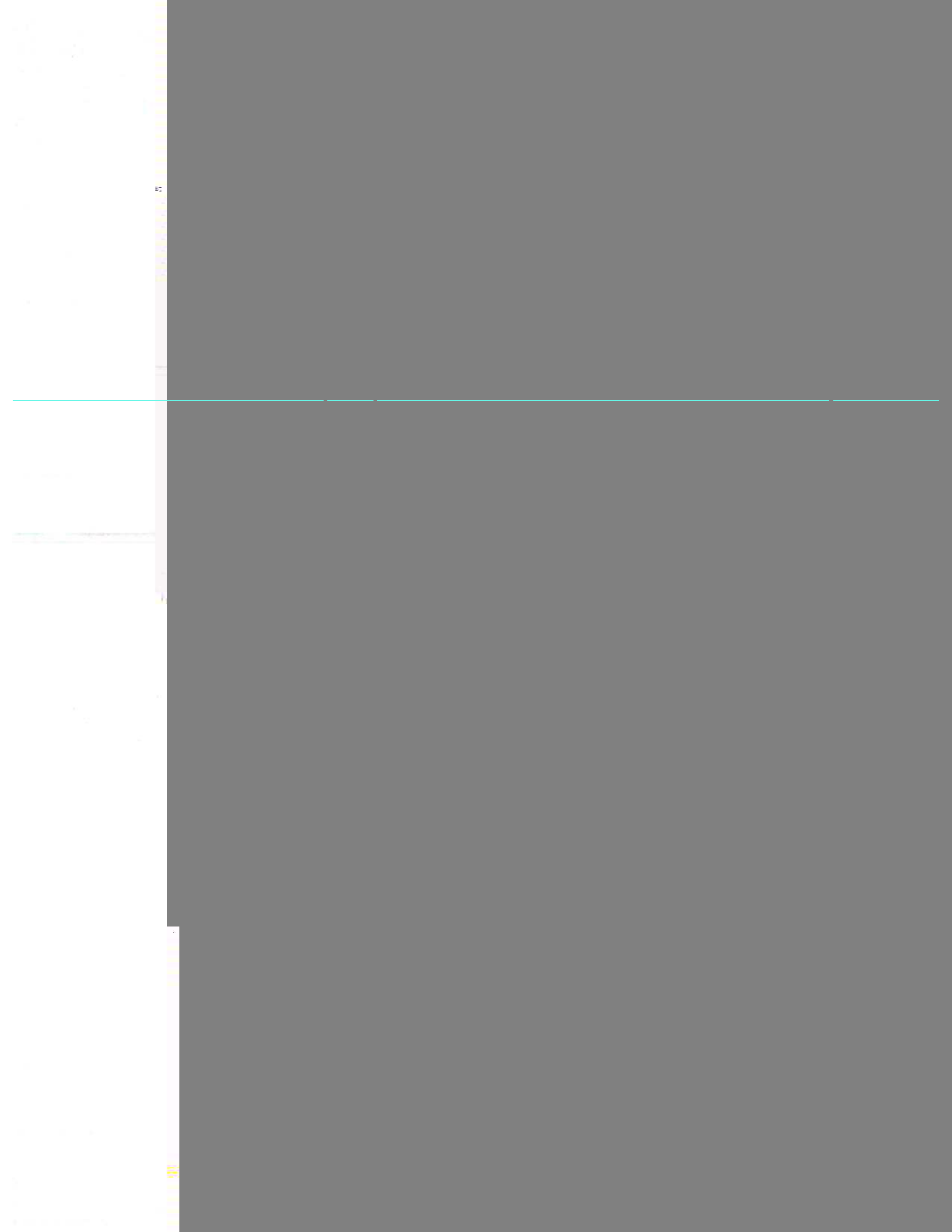



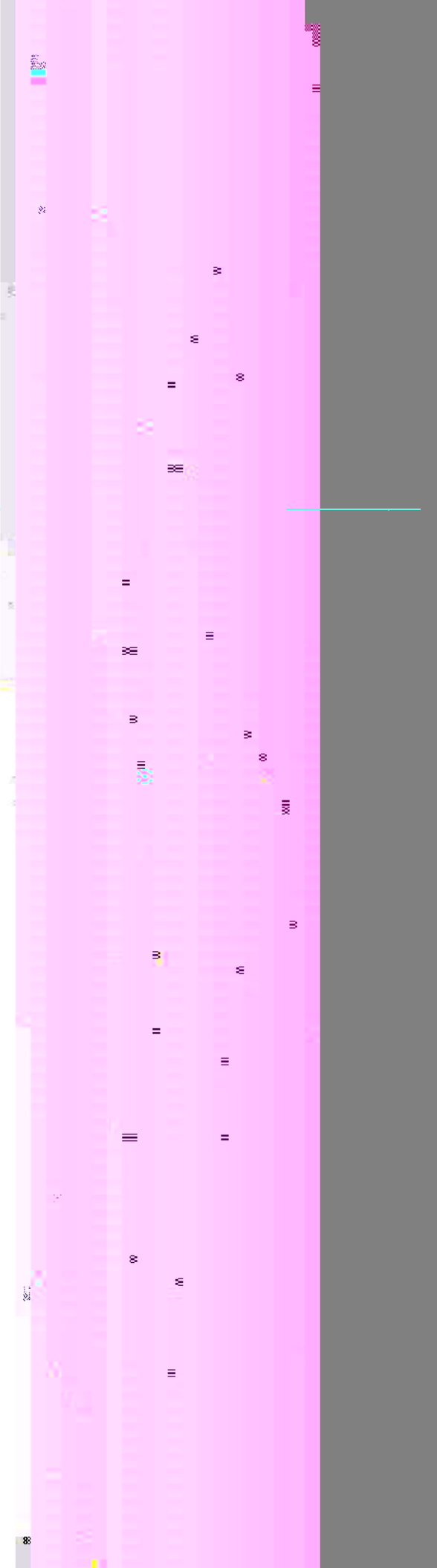

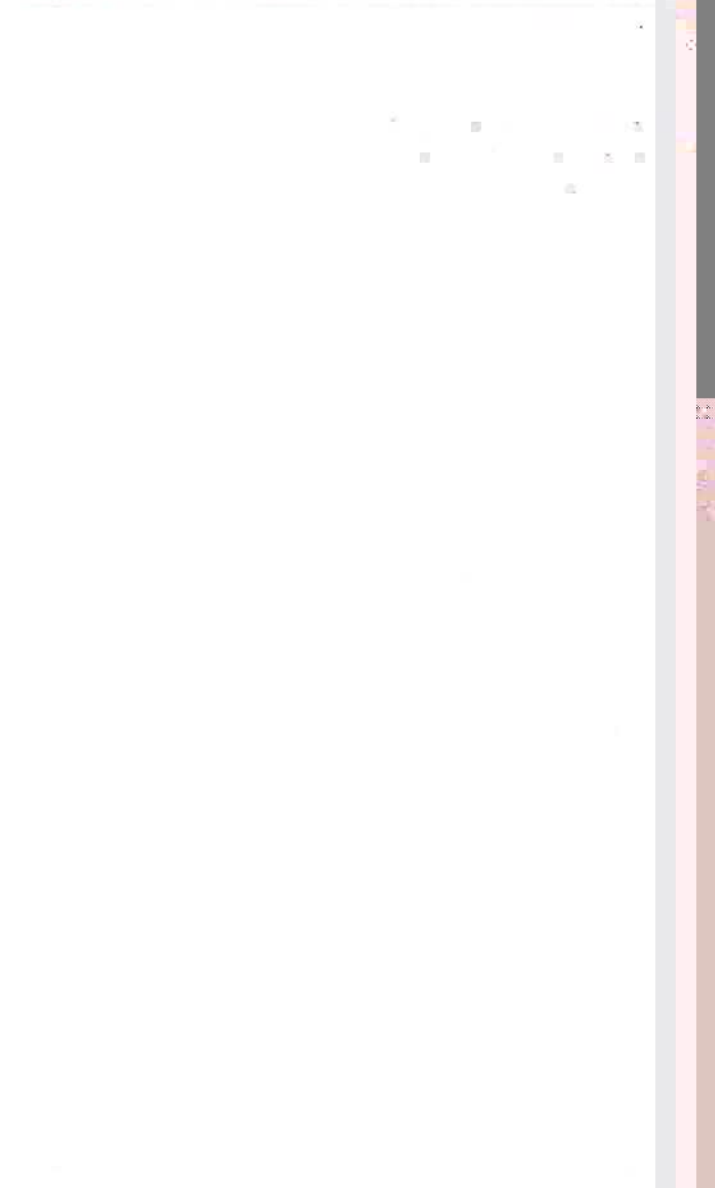
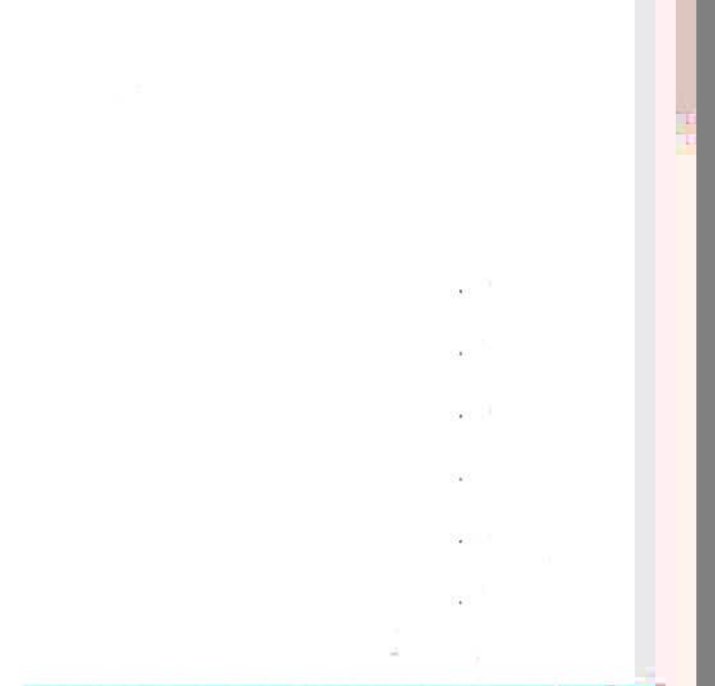











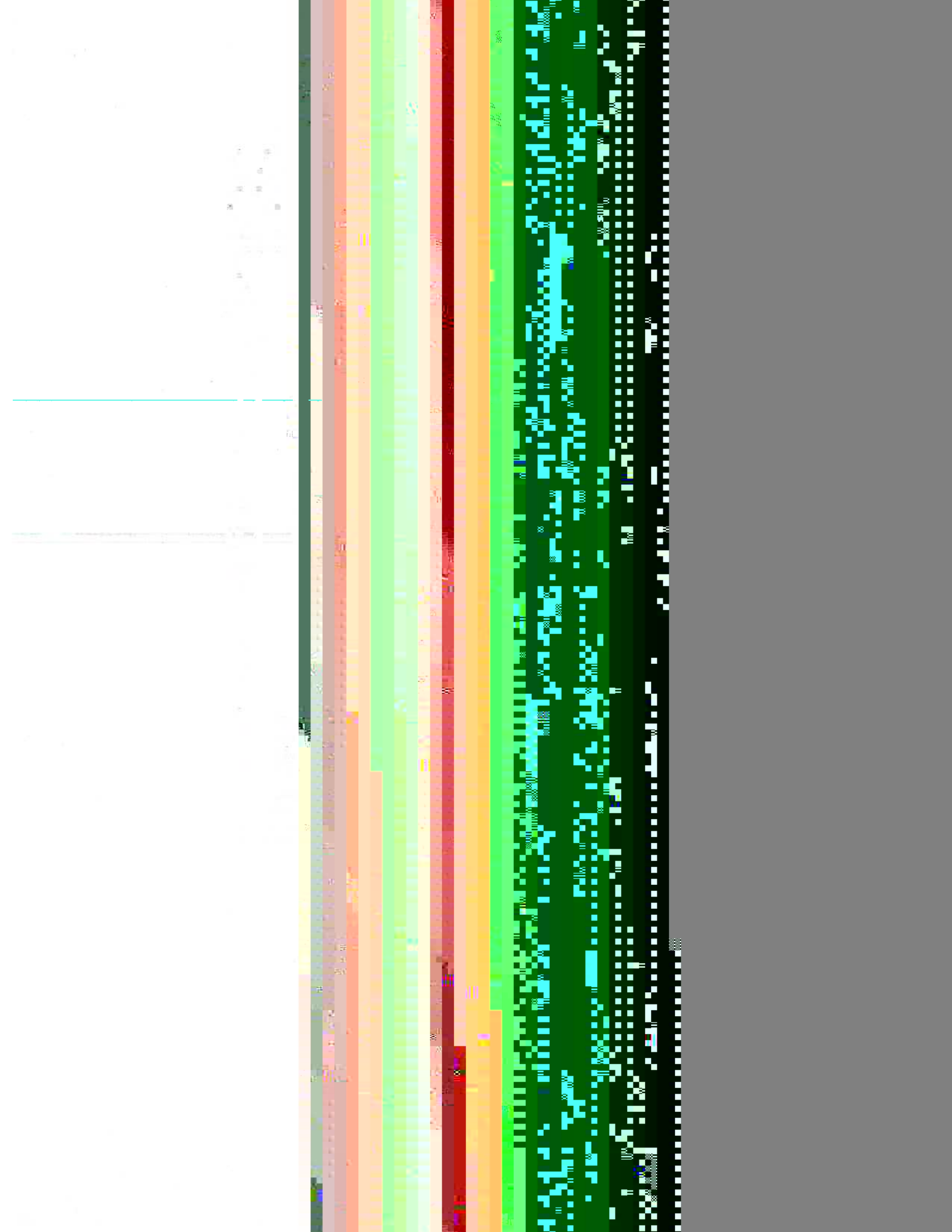

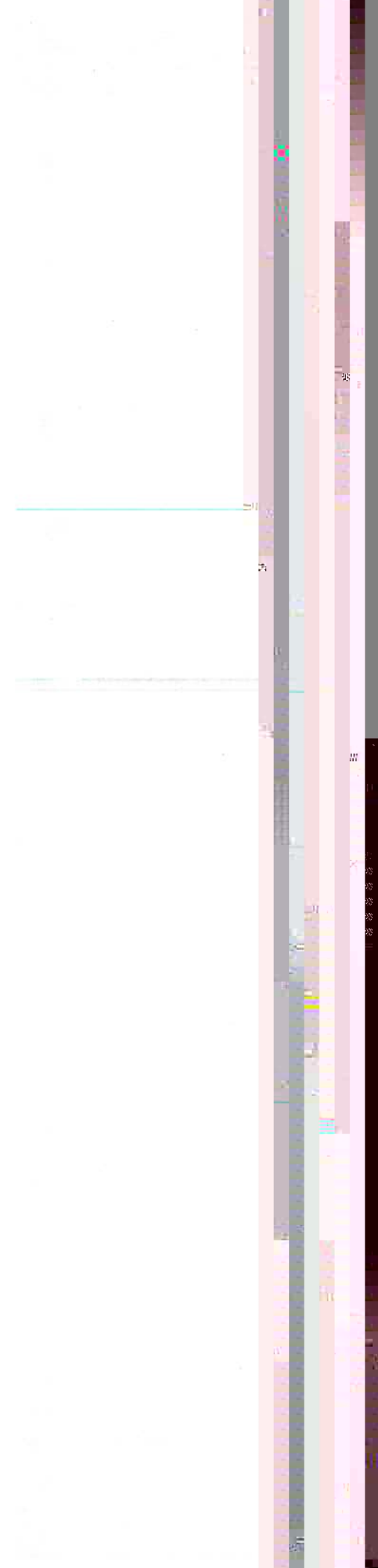









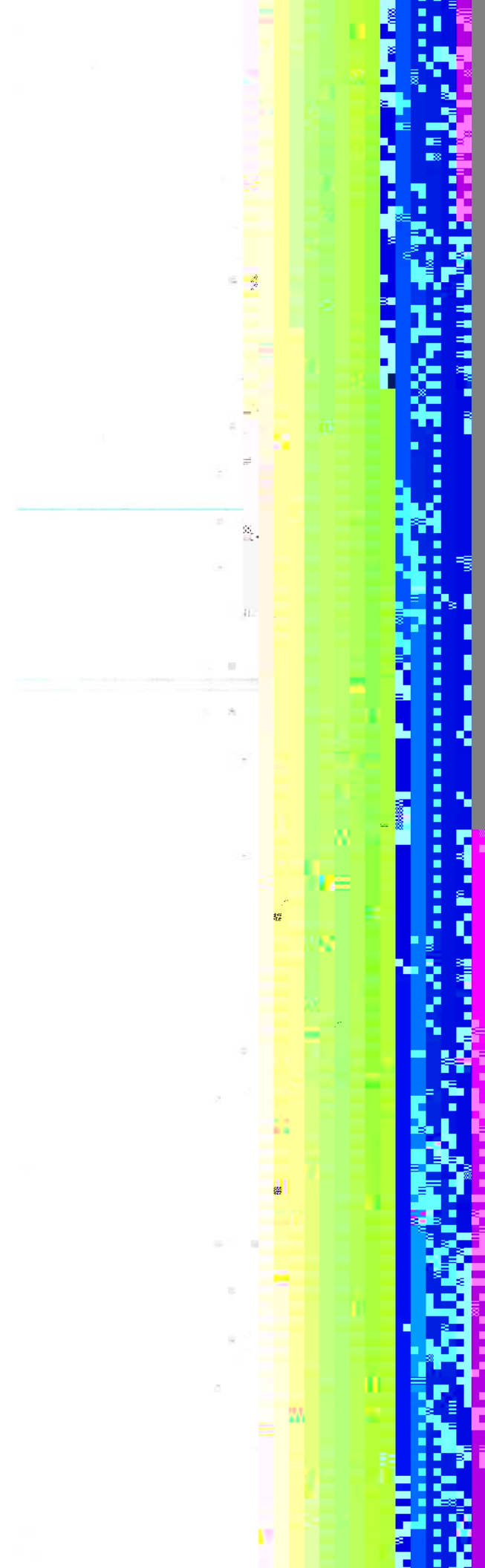





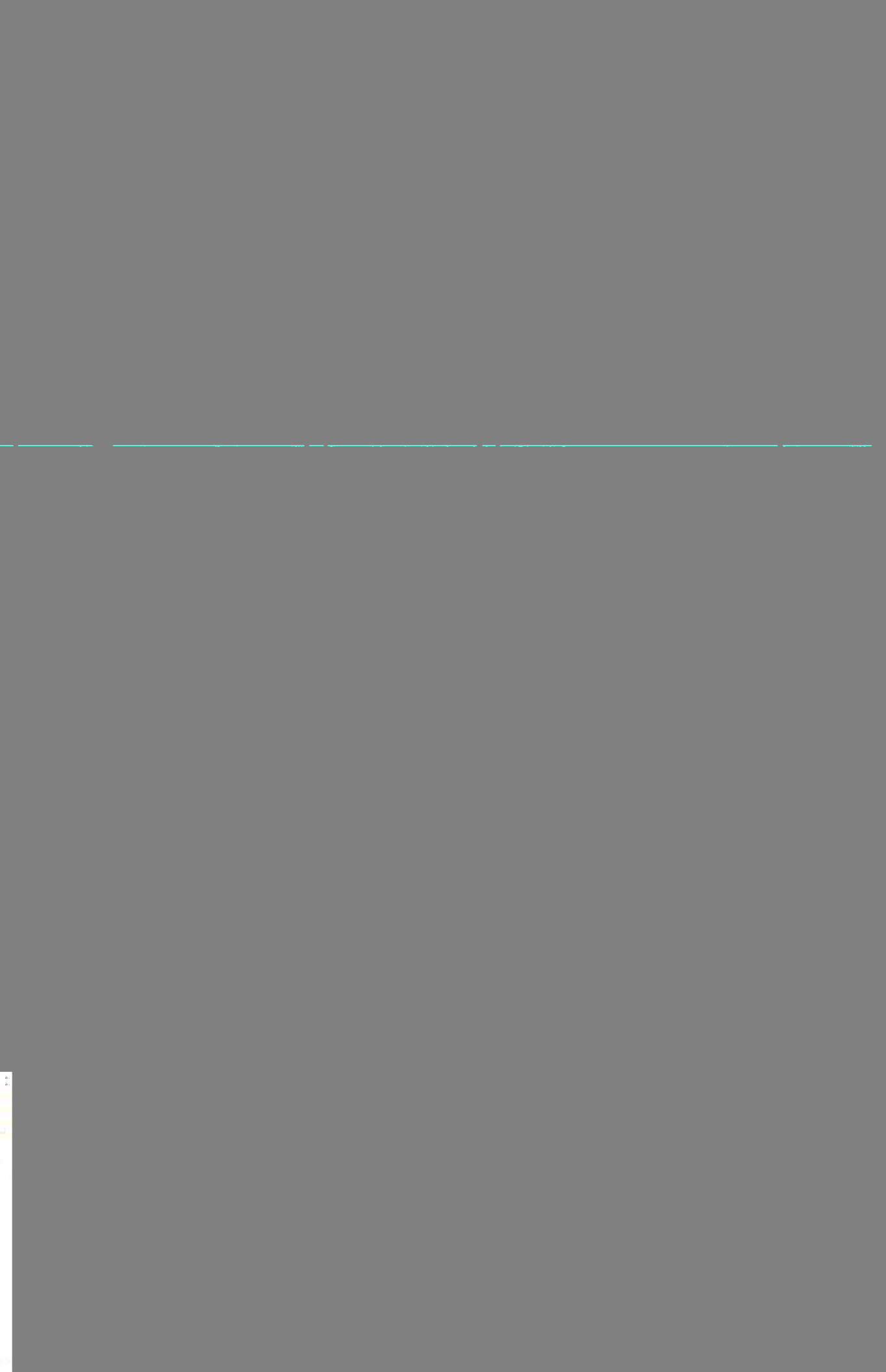



11



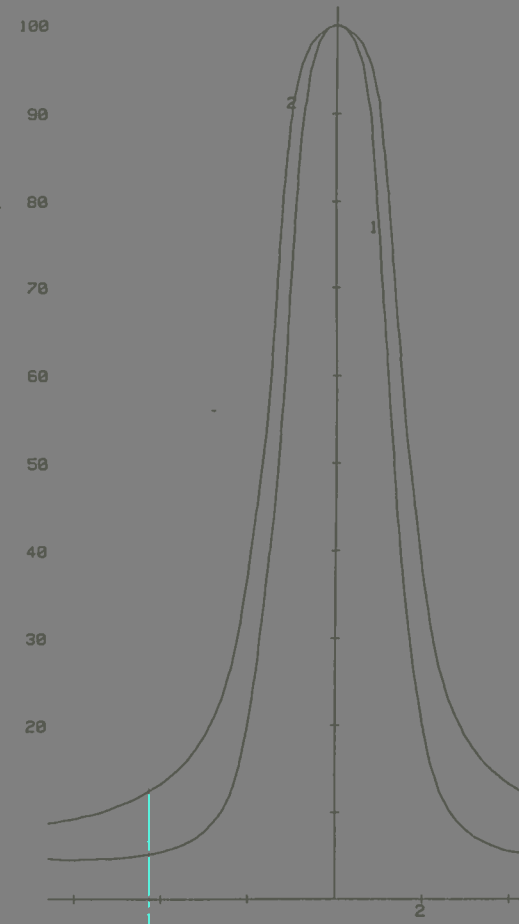











ar dma

a

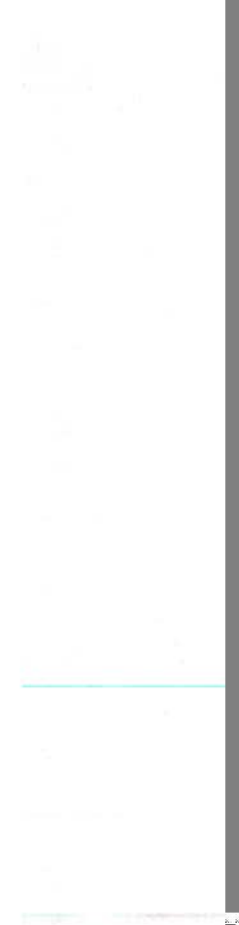

11



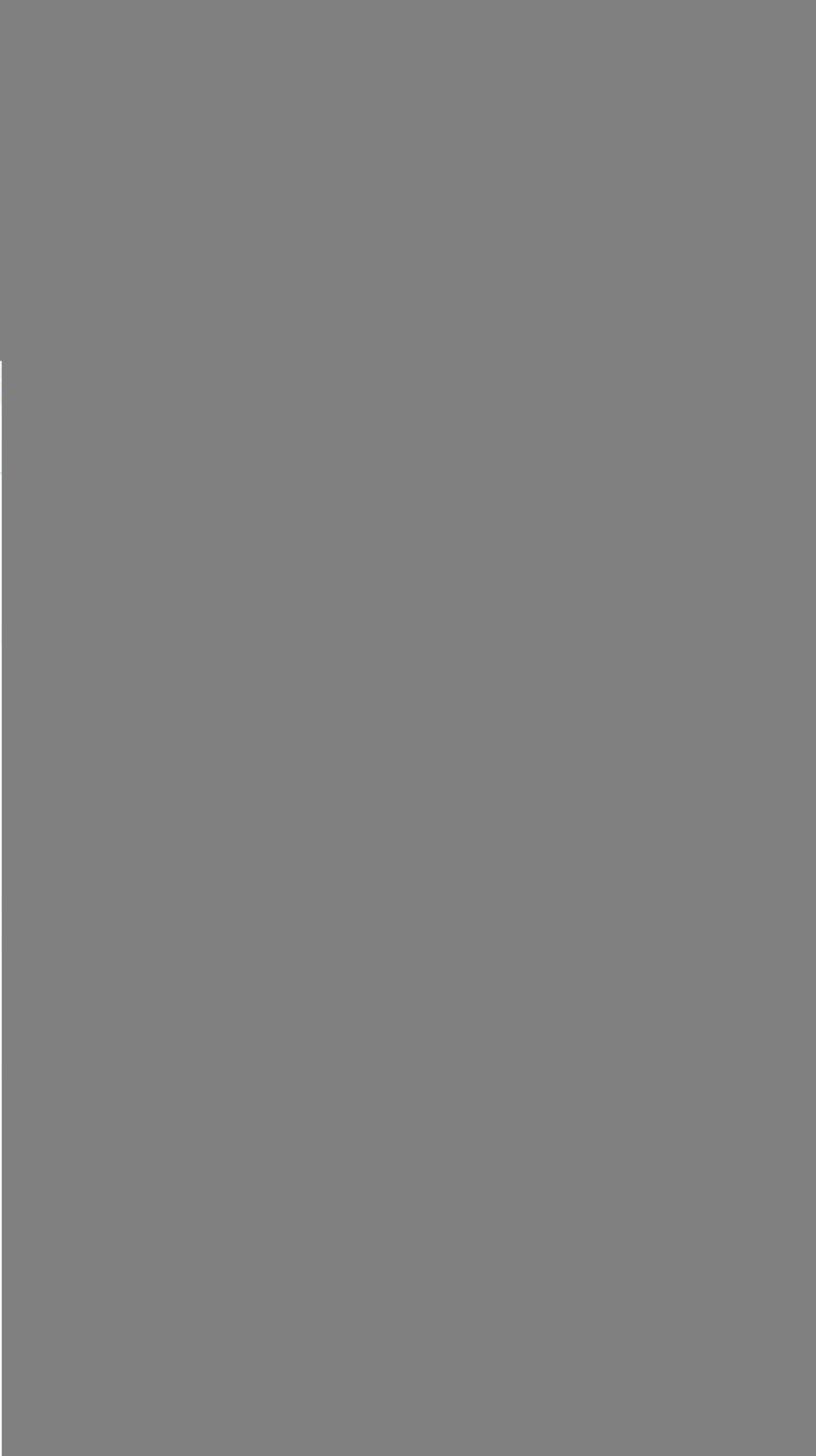
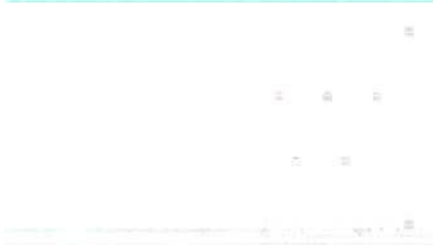













a.

b.

c.

d.

e.

f.

g.

h.

i.

j.

k.

l.

m.

n.

o.

p.

q.

r.

s.

t.

u.

v.

w.

x.

y.

z.

aa.

ab.

ac.

ad.

ae.

af.

ag.

ah.

ai.

aj.

ak.

al.

am.

an.

ao.

ap.

aq.

ar.

as.

at.

au.

av.

aw.

ax.

ay.

az.

**VITA**

**ABSTRACT**

